

RF-190

SCALE : 1:1

UNIT : mm

TD = M4. King

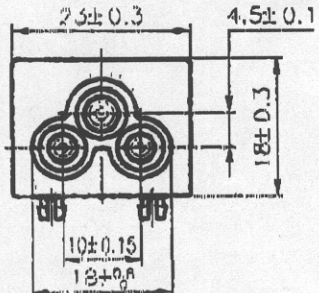
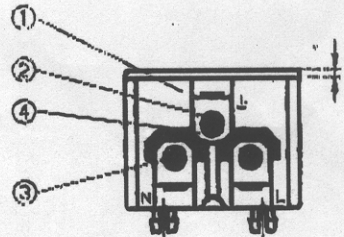
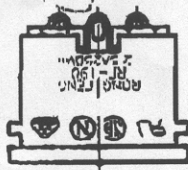

보관용
2000.8.19

RF-190-B

R.F

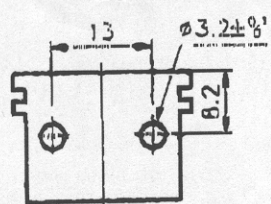
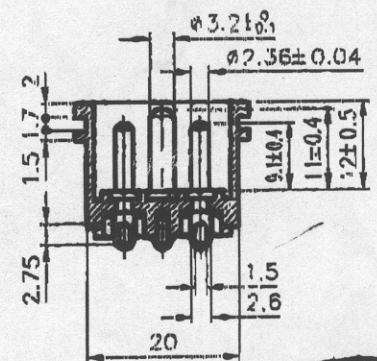
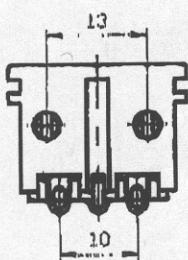
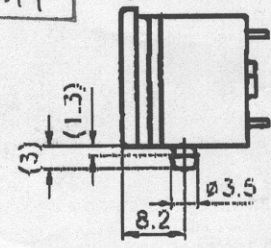

Panel Output

2.5A 250V AC
UL NO: E102641
CSA NO: LR65612
VDE NO: 103273
NEMKO NO: P97101408



			一般公差	
5			3	
1	Soldering PIN Bronze Strip L=0.5mm Tin-Plated		2	尺寸範圍
3	Solid Contact PIN Bronze Strip d=2.36mm Ni-Plated		1	容許公差
2	Solid Contact PIN Bronze Strip d=0.5.2mm Ni-Plated		1	0-10
1	Body Insulator PC 940 Black Color 94V-0		1	±0.3
APPROVED:	CHECK:	DRAWER:	ORDER NO: RF 190-B	10-100
		<i>Huey</i>	DRAWING NO: 870517	±0.5
				100-150
				±0.8
				150-250
				±1